

alphason

What's in the box, instructions, warranty & information:

AW2320-C

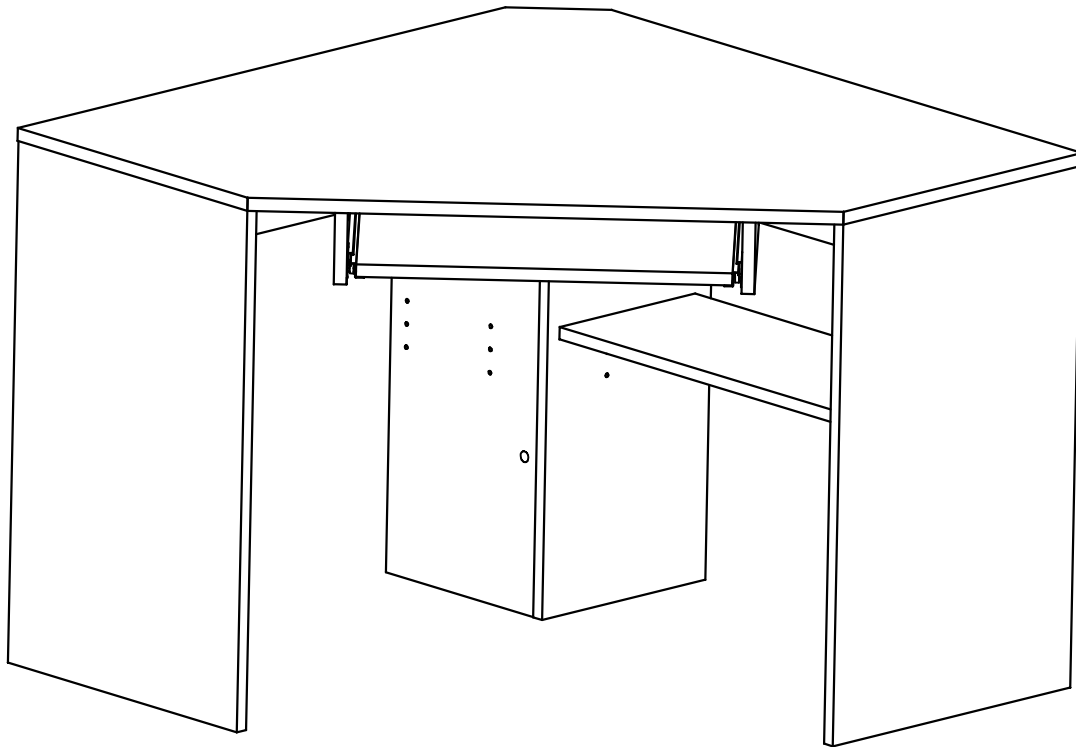

Need help or advice? Missing/damaged parts?
Contact us directly on:

Helpline ☎ 0845 130 6686

International Helpline (English speaking): +44 1942 524 100



Interested in more Alphason products? Visit our website at:
www.alphasondesigns.com



Have a question? Want more information? Email us on?
info@alphasondesigns.com

alphason

What's in the box:
AW2320-C

A
Top panel. A

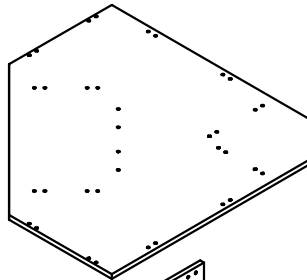

B
Right side panel B

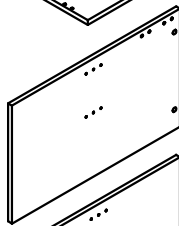

C
Left side panel C

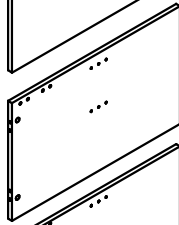

D
Right middle panel. D

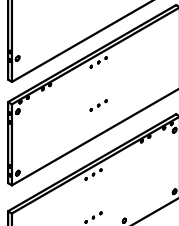

E
Left middle panel. E

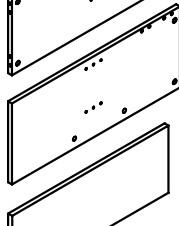

F
Shelf panel. F

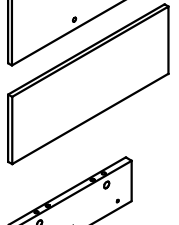

G
Drawer right panel. G

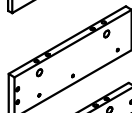

H
Drawer left panel. H

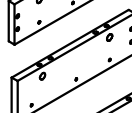

I
Drawer back panel. I



J
Back panel. J

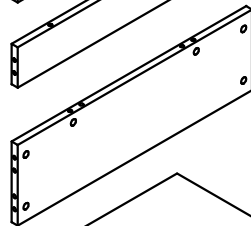

K
Drawer. K

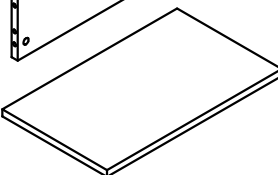

1
3x16 screw x 6



2
Euro screw (runner) x 6



3
Dowel x 30

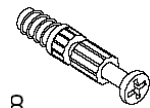

4
Cam x 30



5
Wooden dowel x 30

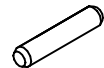

6
Plastic leg x8



7
Cover cap x 30



8
Shelf pin x 4



9
Drawer runner L & R hand

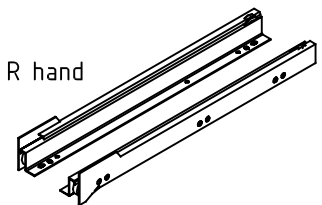

Need help or advice? Missing/damaged parts?
Contact us directly on:

Helpline ☎ **0845 130 6686**

International Helpline (English speaking): +44 1942 524 100



Interested in more Alphason products? Visit our website at:
www.alphasondesigns.com



Have a question? Want more information? Email us on?
info@alphasondesigns.com

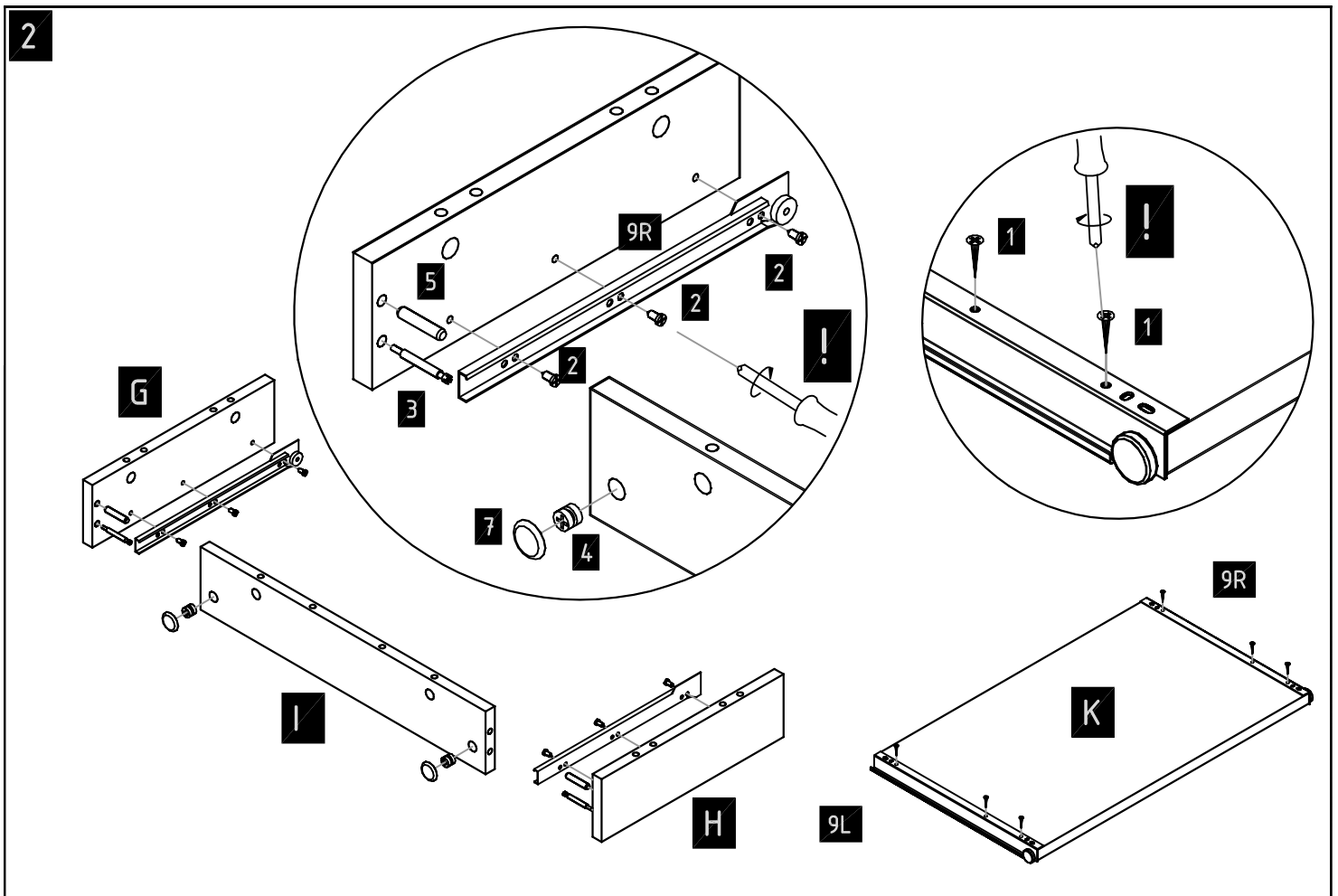
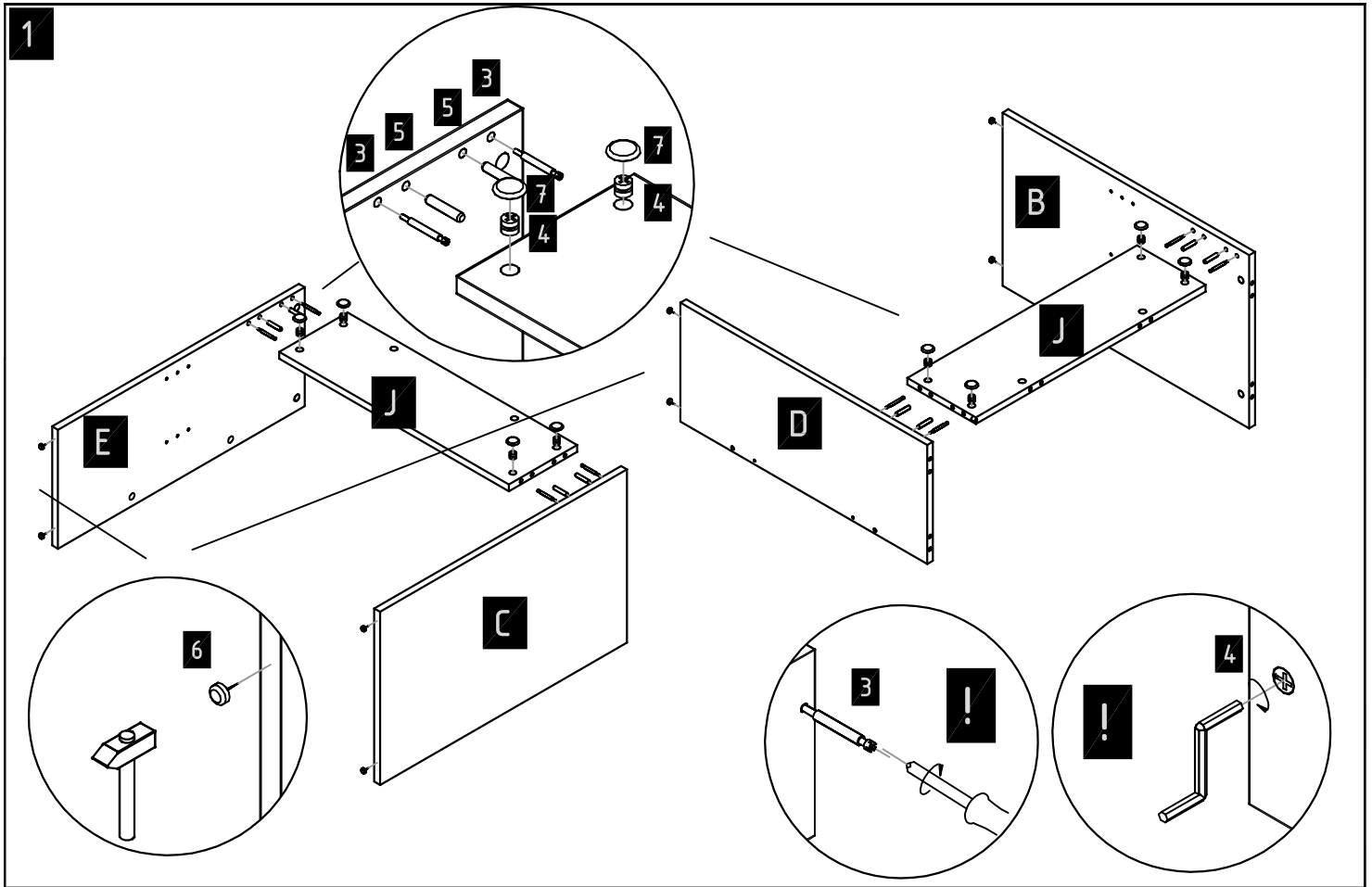

3

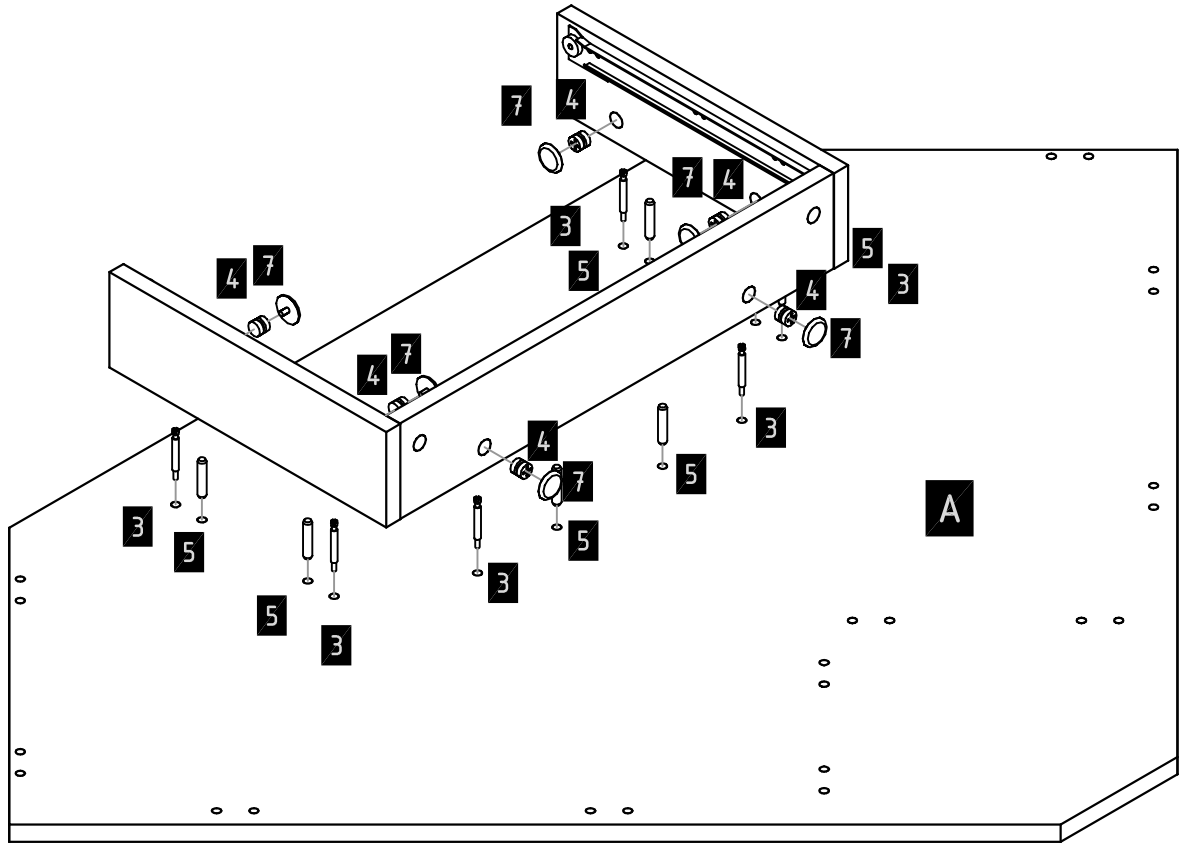

4

